

# CD\_N5

Holder for CD slot/  
Holder til CD indgang  
> iPhone/Smartphone

3.5"-5.5"

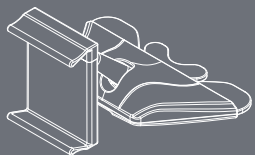

USER GUIDE/  
BRUGERMANUAL

**MOBILINE+** Exclusive

**MOBILINE+** Exclusive  
FEATURES\_HIGH PERFORMANCE ^ COMPATIBLE  
WITH IPHONE/SMARTPHONE ^ 3.5"-5.5"

Size/  
Mål

Component/  
Komponenter

## CD\_N5

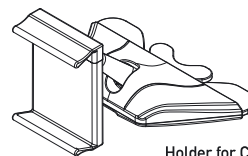
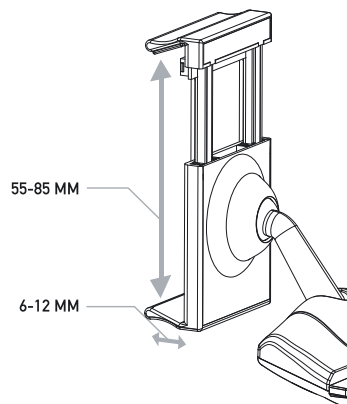

Holder for CD slot/  
Holder til CD indgang

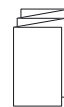

User guide/  
Brugermanual



Sub pads/  
Gummiadptere  
3 pcs./stk.

Features/  
Funktion

Features/  
Funktion

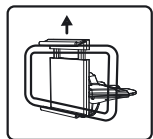

Easy spring  
holder mount/  
Fjederbelastet holder

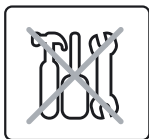

Easy mount/  
Nem at montere

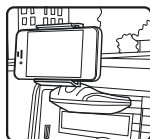

CD slot mount/  
Holder monteres  
i CD indgang



3.5"-5.5"  
iPhone/Smartphone

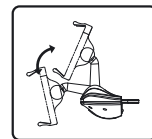

Easy to adjust height/  
Justeres nemt i højden

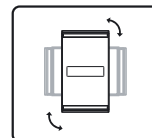

360° Adjustable/  
Justerbar

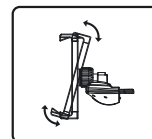

Tiltning function/  
Justerbar vinkel

Parts/  
Dele

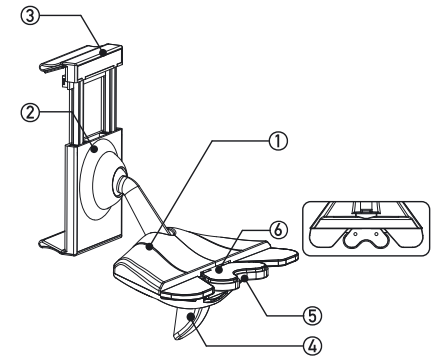

- ① Body/  
Konsol
- ② Holder/  
Holder
- ③ Spring holder/  
Fjederbelastet  
holder
- ④ Locking lever/  
Låsetap
- ⑤ Locking wing/  
Låsegreb
- ⑥ Sub pad hole/  
Plade for  
gummiadapter

How to use sub pad/  
Sådan benytter du en gummiadapter

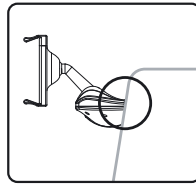

- > Use sub pad when locking wing is loose in the CD slot
- > Benyt en gummiadapter, når låsegrebet sidder løst i CD indgangen

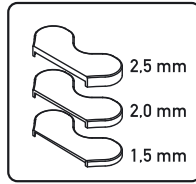

- > There are three types of sub pad thickness 1.5/2.0/2.5 mm
- > Der medfølger 3 gummiadaptere i tykkelse: 1.5/2.0/2.5 mm

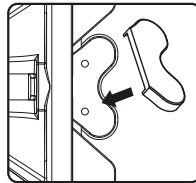

- > Insert the appropriate sub pad to the sub pad hole on the locking wing
- > Sæt passende gummiadapter på pladen på låsegrebet

How to install/  
Sådan monteres holderen

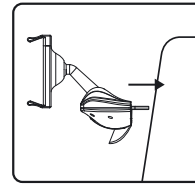

- > Insert the locking wing of the product to the CD slot
- > Indfør låsegreb i CD indgangen

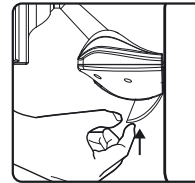

- > Press the locking lever and fasten the locking wing in the CD slot
- > Tryk på låsetappen for at fastgøre låsegreb i CD indgang

How to mount iPhone or Smartphone/  
Sådan monteres din iPhone eller Smartphone

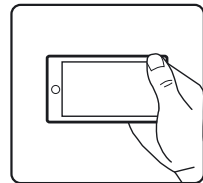

- > Hold the iPhone/Smartphone with one hand
- > Hold din iPhone/Smartphone i den ene hånd

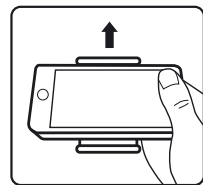

- > Push up the spring holder with the iPhone/Smartphone
- > Tryk din iPhone/Smartphone mod den fjederbelastede holder

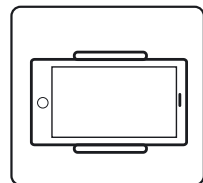

- > Push iPhone/Smartphone into the holder and mount it
- > Skub din iPhone/Smartphone på plads i holder

Caution/  
Advarsel

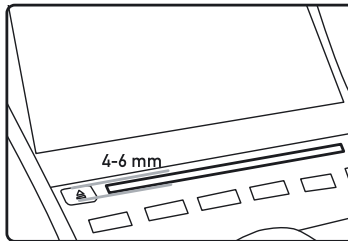

- > Installation is possible from 4-6 mm gap of the CD slot entrance
- > Montering er muligt i CD indgange på mellem 4-6 mm

Caution/  
Advarsel

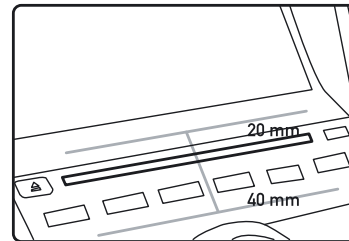

- > 20 mm upward and 40 mm downward from the CD slot is necessary to be installed
- > Ved montering vil konsollen dække 20 mm ovenfor og 40 mm nedenfor CD indgang