



INTERFACCIA COMANDI AL VOLANTE
STEERING WHEEL CONTROLS

PLUG&PLAY
CONNETTORE ISO / ISO CONNECTOR

04042



Istruzioni di montaggio **IT**
Installation instructions **EN**
Instructions de montage **FR**
Montageanleitung **DE**
Instrucciones para el montaje **ES**

ALFA ROMEO - FIAT - LANCIA

Precauzioni • Warnings • Précautions • Vorsicht • Precauciones

IT • Per l'installazione rivolgersi al personale tecnico qualificato. • Usare solo con impianto elettrico a 12V DC con negativo a massa. • Quando si sostituisce il fusibile, utilizzarne uno con lo stesso valore di amperaggio. • Non aprire l'unità e non tentare di ripararla, consultare il proprio rivenditore o personale tecnico qualificato. • Assicurarsi che oggetti estranei non entrino all'interno dell'apparecchio, potrebbero causare malfunzionamenti, generare cortocircuiti elettrici o un'esposizione rischiosa ai raggi laser se presenti. • Accendere l'apparecchio solo quando la temperatura dell'abitacolo è nella norma. • Non collegare alcun cavo in luoghi dove potrebbe ostacolare il funzionamento dei dispositivi di sicurezza dell'auto.

GB • Installation to be carried out by trained technical personnel • Make sure you have 12V DC, with negative-pole to mass • When replacing fuse, always use fuse with same Ampere-value • Never open the unit, nor try to repair yourself. Always ask your Retailer or authorized technical staff • Make sure that no foreign objects fall into the unit, they would cause malfunctions, short-circuits or exposure to dangerous laser-rays • When switching-on, make sure that temperature inside passenger-compartment is at a normal level • When placing the cables, keep away from all car security-devices.

FR • Se servir du personnel technique qualifié pour l'installation. • Utiliser uniquement dans des installations électriques à 12V DC avec négatif à masse. • Quand on remplace un fusible, se servir d'un autre ayant le même ampérage. • Ne pas ouvrir l'appareil pour essayer de le réparer, contacter votre revendeur ou un personnel technique qualifié • Eviter que des corps étrangers entrent dans l'appareil, car ils peuvent provoquer des mauvais fonctionnements, des courts circuits; éviter aussi l'exposition risquée aux rayons laser si présents. • Allumer l'appareil seulement lorsque la température interne du véhicule est dans la norme • Ne brancher aucun câble dans des endroits pouvant causer les obstacles au fonctionnement des dispositifs de sécurité du véhicule.

Precauzioni • Warnings • Précautions • Vorsicht • Precauciones

DE • Die Installation muss durch technische Fachkräfte vorgenommen werden • Nur bei 12V DC verwenden, mit Negativ-Pol zur Masse • Beim Auswechseln, immer Sicherungen derselben Ampere-Stärke verwenden • Nie versuchen, das Gerät zu öffnen oder eigenhändig zu reparieren. Immer den Händler bzw. technische Fachkräfte zu Rate ziehen • Sicherstellen, dass keinerlei Fremdkörper in das Gerät eindringen können. Diese würden Betriebsstörungen, Kurzschlüsse oder die Entfaltung gefährlicher Laser-Strahlen verursachen • Gerät nur dann einschalten, wenn die Temperatur im Wagen-Innenraum auf normalem Niveau ist • Kabel fernhalten von allen Sicherheits-Geräten des Wagens.

ES • Para la instalación, contactar exclusivamente con empresas especializadas y personal técnicamente cualificado. • Usar solo en vehículos con alimentación de 12V DC y negativo a masa • Cuando se sustituya el fusible, utilizar exclusivamente fusibles con el mismo amperaje • No abrir la unidad y no intentar repararla, consultar al revendedor o personal técnico cualificado • Asegurarse de que no entren objetos extraños en su interior, ya que impediría el buen funcionamiento, generar cortocircuitos eléctricos, además se corre el riesgo de una exposición muy perjudicial a los rayos laser, si están presente • Encender el aparato solo cuando la temperatura del habitáculo se haya normalizado • No conectar ningún cable en lugares que puedan obstaculizar el funcionamiento de los dispositivos de seguridad del coche

IT

Interfaccia per recupero dei comandi volante e servizi su veicoli dotati di linea CAN per il collegamento su autoradio provviste dell'ingresso specifico. I segnali in uscita sono i seguenti:

Comandi a volante

Sottochiave +12V (solo auto con protocollo CAN-BUS)

Per il recupero di ulteriori servizi CAN-BUS (Illuminazione - luce retromarcia - freno a mano - segnale odometrico) è necessario il modulo aggiuntivo **04020** integrabile sulla interfaccia tramite un semplice collegamento Plug&Play.

I marchi compatibili sono i seguenti:

ALPINE - BLAUPUNKT - CLARION - JVC - KENWOOD - PHONOCAR - PIONEER - SONY e devono essere provviste di CAVO INGRESSO REMOTO PER COMANDI VOLANTE.

EN

Interface for restoring SWC and services on vehicles equipped with CAN line. Connection to car radios provided with the specific input.

Output signals:

Steering wheel control

Ignition +12V (car with CAN-BUS protocol only).

For restoring further CAN-BUS services (lighting - reversing light - handbrake - odometer signal), an additional module **04020** is required, which can be integrated into the 04040 interface via a simple Plug&Play connection.

Compatible brands:

ALPINE - BLAUPUNKT - CLARION - JVC - KENWOOD - PHONOCAR - PIONEER - SONY.

They must be equipped with REMOTE INPUT CABLE FOR SWC.

IT

Collegare il connettore ISO sulla autoradio e il connettore specifico sulla vettura (verificare la compatibilità del modello di interfaccia prima del collegamento). Effettuare il collegamento di entrambi i cablaggi (ISO/specifico e connessione filo comandi autoradio) sulla interfaccia e successivamente girare il quadro della vettura.

Verificare che la radio risponda ai comandi volante della vettura prima di terminare l'installazione della autoradio con il fissaggio in plancia.

EN

Connect the ISO connector on the car radio and the specific connector on the car (check the compatibility of the interface model before connecting). Connect both cables (specific ISO and car radio control wire connection) on the interface and then turn the ignition of the vehicle. Check that the radio responds to the car's steering wheel commands before completing the installation of the car sound system, fixing it on the dashboard.

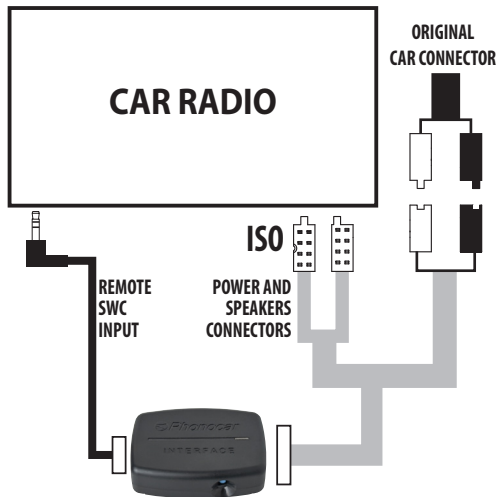

IT

Inserire un piccolo cacciavite nella feritoia presente sullo sportello laterale (1), sollevarlo delicatamente facendo leva verso il basso (2) fino allo sgancio dal box.

Sotto lo sportello sono presenti gli interruttori per l'impostazione vettura e autoradio.

Seguire lo schema impostazioni veicolo per configurare il corretto profilo dell'auto e selezionare il marchio della propria autoradio.

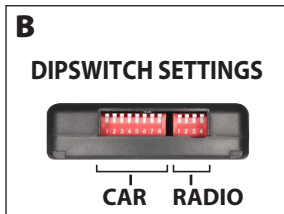

EN

Introduce a small screwdriver into the slot on the side cover (1), carefully lift it by levering downwards (2) until it releases from the box.

The switches for setting the car and car radio are placed under the cover. Follow the vehicle settings diagram to configure the correct car profile and select the brand of your car radio

IT

Individuare la casa automobilistica e il modello della propria vettura, successivamente impostare gli interruttori lato sinistro come indicato:

EN

Select the car manufacturer and model of your car, then set the switches on the left side as shown below:

ALFA ROMEO	DIPSWITCH SETTING	CONNECTION CABLE
156 04>06 159 06>11 Brera 06>10 Giulietta 10>14 MODEL PLUG&PLAY cod. 04042	<p>DIP ON ↓</p>	<p>CAN H CAN L BATTERY GROUND</p>
Mito 08>14 04042 PLUG&PLAY	<p>DIP ON ↓</p>	

FIAT	DIPSWITCH SETTING	CONNECTION CABLE
<p>500 08-14</p> <p>MODEL PLUG&PLAY cod. 04042</p>	<p>DIP ON ↓</p>	<p>CAN H</p> <p>CAN L</p> <p>BATTERY GROUND</p>
<p>Grande Punto 07>11</p> <p>Punto 11</p> <p>MODEL PLUG&PLAY cod. 04042</p>	<p>DIP ON ↓</p>	
<p>LANCIA</p> <p>Y 07>11</p> <p>MODEL PLUG&PLAY cod. 04042</p>	<p>DIP ON ↓</p>	

IT

Impostare gli interruttori lato destro dell'interfaccia in base alla propria autoradio e collegare il cablaggio seguendo le indicazioni seguenti:

ATTENZIONE:

In caso di collegamento su sistemi multimediali con comandi a volante resistivi integrati (Universali), sarà necessario proseguire la programmazione sul proprio libretto di istruzioni una volta settata e terminata l'installazione dell'interfaccia.

EN

Set the switches on the right side of the interface according to your car radio and connect the wiring according to the following instructions:

WARNING:

In case of connection to multimedia systems with integrated resistive steering wheel controls (Universal), it will be necessary to continue programming on your instruction manual once the interface installation has been set up and completed.

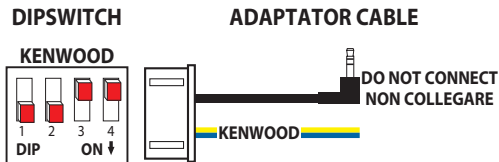
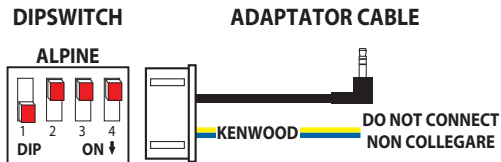

DIPSWITCH

BLAUPUNKT

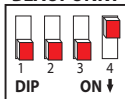

RESISTIVE



CLARION

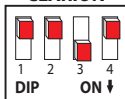

JVC >2011

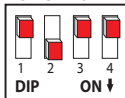

JVC 2011 >

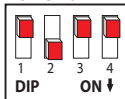

DIPSWITCH

PHONOCAR

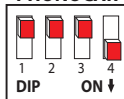

RESISTIVE



PIONEER

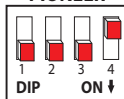

SONY

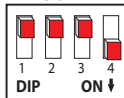

UNIVERSAL

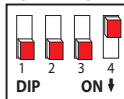

RESISTIVE



INTERFACE COMMANDES AU VOLANT
LENKRAD -STEUERUNGEN

PLUG&PLAY
CONNECTEUR ISO / ISO KONNEKTOR

04042

Instructions de montage **FR**
Montageanleitung **DE**

ALFA ROMEO - FIAT - LANCIA

FR

Interface pour récupérer les commandes au volant et les services sur les véhicules équipés de la ligne CAN. Branchement sur les autoradios équipés d'une entrée spécifique. Signaux de sortie sont les suivants:

Commandes au volant

Après-contact +12V (voiture avec protocole CAN-BUS uniquement).

Pour récupérer les autres services CAN-BUS (éclairage - feu de recul - frein à main - signal d'odométrie), il faut utiliser le module complémentaire **04020**, qui peut être intégré dans l'interface grâce à un simple branchement Plug&Play.

Marques d'autoradios compatibles:

ALPINE - BLAUPUNKT - CLARION - JVC - KENWOOD - PHONOCAR - PIONEER - SONY

qui doivent être équipés du CÂBLE D'ENTRÉE REMOTE POUR LES COMMANDES AU VOLANT.

DE

Interfaces zur Wiederherstellung von Lenkradsteuerungen und Diensten an Fahrzeugen mit CAN-Leitung. Anschluss an Autoradios, die mit dem spezifischen Eingang ausgestattet sind.

Lenkradsteuerung

Zündung +12V (nur Fahrzeug mit CAN-BUS-Protokoll). Zur Wiederherstellung weiterer CAN-BUS-Dienste (Beleuchtung - Rückfahrlicht - Handbremse - Tacho) wird das Zusatzmodul **04020** benötigt, das über eine einfache Plug&Play-Verbindung in das 04040-Interface integriert werden kann.

Kompatible Marken:

ALPINE - BLAUPUNKT - CLARION - JVC - KENWOOD - PHONOCAR - PIONEER - SONY.

Die Autoradios müssen mit Remote Eingangs-Kabel für Lenkradsteuerungen ausgestattet sein.

FR

Brancher le connecteur ISO sur l'autoradio et le connecteur spécifique sur la voiture (vérifier la compatibilité du modèle d'interface avant d'effectuer tout branchement). Brancher les deux câbles (câble spécifique ISO et branchement du fil pour les commandes de l'autoradio) sur l'interface, puis tourner le contact du véhicule. Vérifier que l'autoradio répond aux commandes au volant du véhicule, avant de terminer l'installation du système audio de la voiture avec sa fixation sur le tableau de bord.

DE

Schließen Sie den ISO-Stecker an das Autoradio und den spezifischen Stecker an das Fahrzeug an (überprüfen Sie vor dem Anschluss die Kompatibilität des Interface-Modells). Schließen Sie beide Kabel (spezifischer ISO- und Autoradio Kabelverbindung) an das Interface an und dann das Fahrzeug über die Zündung anlassen. Überprüfen Sie, ob das Radio auf die Lenkradsteuerungen des Fahrzeugs reagiert, bevor Sie die Installation des Autoradios abschließen und dieses auf dem Armaturenbrett befestigen.

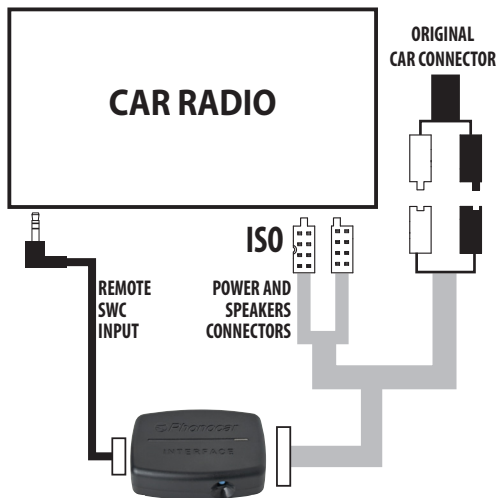

FR

Tourner un petit tournevis dans la fente de la trappe latérale (1), le soulever doucement en tirant vers le bas (2) jusqu'au déclenchement du boîtier.



Les interrupteurs pour le réglage de la voiture et de l'autoradio se trouvent sous la trappe.

Suivre le schéma des paramètres du véhicule pour configurer le profil de la voiture et sélectionner la marque de votre autoradio.

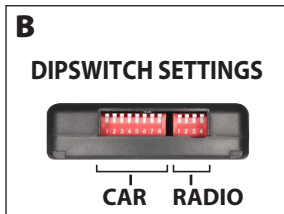

DE

Einen kleinen Schraubenzieher in den Eingang der Seitenabdeckung (1) einführen, vorsichtig anheben, indem man ihn nach unten (2) drückt, bis er sich aus der Box löst.

Die Schalter zur Einstellung des Auto- und Autoradios befinden sich unter der Abdeckung.

Befolgen Sie das Diagramm der Fahrzeugeinstellungen, um das richtige Fahrzeugprofil einzustellen und die Marke Ihres Autoradios auszuwählen.

FR

Sélectionner le constructeur automobile et le modèle de votre voiture, puis régler les interrupteurs à gauche comme indiqué ci-dessous :

DE

Wählen Sie den Fahrzeughersteller und das Modell Ihres Autos aus und stellen Sie dann die Schalter auf der linken Seite wie unten gezeigt ein:

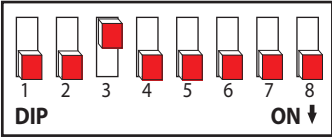
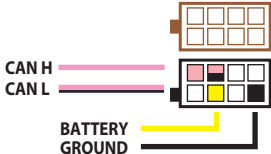
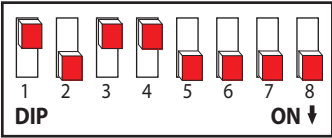
ALFA ROMEO	DIPSWITCH SETTING	CONNECTION CABLE
<p>156 04>06 159 06>11 Brera 06>10 Giulietta 10>14 MODEL PLUG&PLAY cod. 04042</p>		
<p>Mito 08>14 04042 PLUG&PLAY</p>		

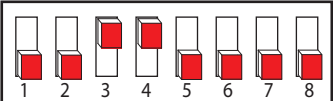
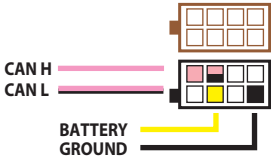
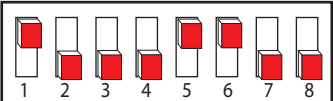
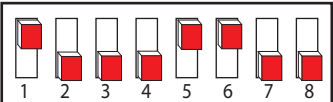
FIAT	DIPSWITCH SETTING	CONNECTION CABLE
<p>500 08-14</p> <p>MODEL PLUG&PLAY cod. 04042</p>	 <p>DIP ON ↓</p>	 <p>CAN H</p> <p>CAN L</p> <p>BATTERY GROUND</p>
<p>Grande Punto 07>11</p> <p>Punto 11</p> <p>MODEL PLUG&PLAY cod. 04042</p>	 <p>DIP ON ↓</p>	
<p>LANCIA</p> <p>Y 07>11</p> <p>MODEL PLUG&PLAY cod. 04042</p>	 <p>DIP ON ↓</p>	

FR

Régler les commutateurs sur le côté droit de l'interface en fonction de votre autoradio et brancher le câblage selon les instructions suivantes:

AVERTISSEMENT:

En cas de branchement sur des systèmes multimédia avec commandes au volant résistives intégrées (universelles), il sera nécessaire de continuer la programmation sur votre manuel d'instructions, une fois que l'installation de l'interface aura été configurée et terminée.

DE

Stellen Sie die Schalter auf der rechten Seite des Interfaces gemäß Ihrem Autoradio ein und schließen Sie die Kabel gemäß den folgenden Anweisungen an:

WARNUNG:

Bei Anschluss an Multimediasysteme mit integrierter resistiver Lenkradsteuerung (Universal) ist es notwendig, die Programmierung wie in Ihrer Betriebsanleitung angezeigt fortzusetzen, sobald die Installation eingestellt und abgeschlossen ist.

DIPSWITCH

ADAPTATOR CABLE

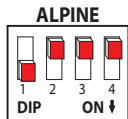

DIPSWITCH

ADAPTATOR CABLE

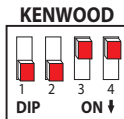

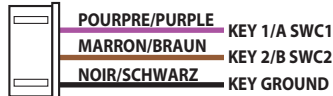
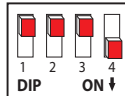
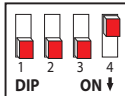
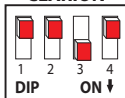
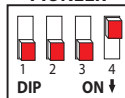
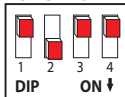
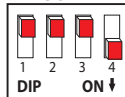
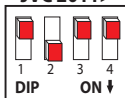
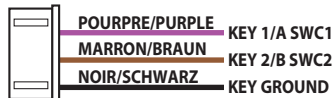
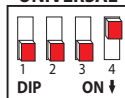
DIPSWITCH
ADAPTATOR CABLE
DIPSWITCH
ADAPTATOR CABLE
BLAUPUNKT
RESISTIVE
PHONOCAR
RESISTIVE

CLARION

PIONEER

JVC >2011

SONY

JVC 2011>

UNIVERSAL
RESISTIVE

MANDOS DE VOLANTE

PLUG&PLAY
CONECTOR ISO

04042

Instrucciones para el montaje **ES**

ALFA ROMEO - FIAT - LANCIA

ES

Interfaz para recuperar los mandos de volante y los servicios, en los vehículos dotados de línea CAN-BUS, para la conexión con autorradios after market que disponen del control remoto SWC.

Las señales de salida del art. 04040 son las siguientes:

Mandos de volante

Bajo-llave +12V (Coche con protocolo CAN-BUS solamente).

Para la recuperación de ulteriores servicios CAN-BUS (Iluminación - Luz marcha atrás - Freno de mano - Señal odometrico) es necesario el modulo adicional **04020** integrable con el interface 04040 mediante una sencilla conexión Plug&Play. Las marcas de autorradios compatibles son las siguientes: **Alpine - Blaupunkt - Clarion - JVC - Kenwood - Phonocar - Pioneer - Sony** y deben absolutamente disponer de la SALIDA PARA EL CONTROL REMOTO DE LOS MANDOS DE VOLANTE.

Introducir un pequeño destornillador en la ranura presente en una tapa lateral (1), levantarlo delicadamente haciendo leva hacia abajo (2) hasta su completa salida de la centralita.



Debajo de la tapa están presentes una serie de micro switch que sirven para configurar la centralita según el coche y el autorradio. Seguir el esquema para la configuración del modelo de vehículo y además para configurar la marca de la autorradio.

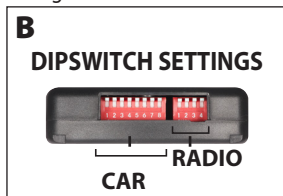

ES

Conectar el conector ISO en la autorradio y el conector específico al coche (verificar una vez más la compatibilidad del modelo de interfaz antes de conectarlo).

Efectuar la conexión de ambos cableados (ISO/específico y conexión cable/Jack con el control remoto de los mandos de volante del autorradio) con el interfaz y a continuación girar la llave de contacto para que se encienda el cuadro de instrumentos del coche.

Verificar que la radio responda a los mandos de volante del vehículo antes de terminar de montar el autorradio en el salpicadero.

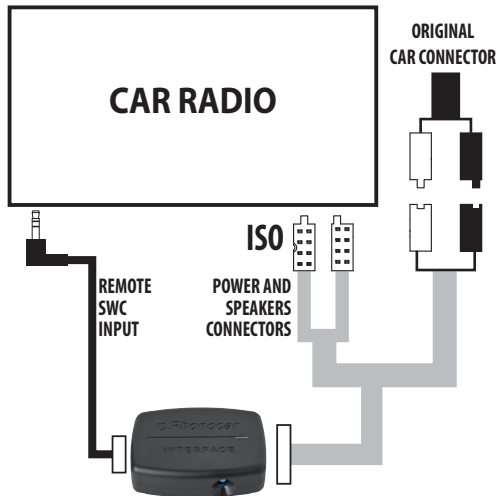

ES

CONFIGURACIÓN VEHÍCULO

Localizar la marca automovilística y el modelo de coche, a continuación configurar los micros switch en el lado izquierdo como indicado.

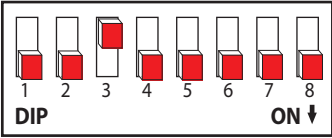
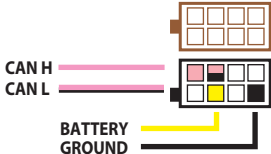
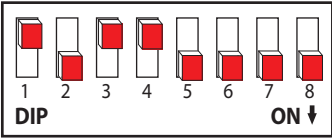
ALFA ROMEO	DIPSWITCH SETTING	CONNECTION CABLE
<p>156 04>06 159 06>11 Brera 06>10 Giulietta 10>14 MODEL PLUG&PLAY cod. 04042</p>		
<p>Mito 08>14 04042 PLUG&PLAY</p>		

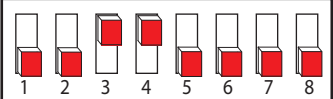
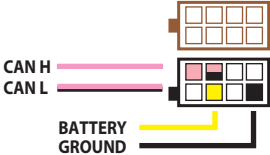
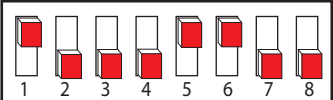
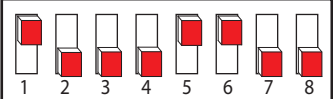
FIAT	DIPSWITCH SETTING	CONNECTION CABLE
<p>500 08-14</p> <p>MODEL PLUG&PLAY cod. 04042</p>	 <p>DIP ON ↓</p>	 <p>CAN H</p> <p>CAN L</p> <p>BATTERY GROUND</p>
<p>Grande Punto 07>11</p> <p>Punto 11</p> <p>MODEL PLUG&PLAY cod. 04042</p>	 <p>DIP ON ↓</p>	
<p>LANCIA</p> <p>Y 07>11</p> <p>MODEL PLUG&PLAY cod. 04042</p>	 <p>DIP ON ↓</p>	

ES

Configurar los micros switch (DIPSWITCH) lado derecho del interfaz según el propio autorradio y conectar el cableado o bien el Jack siguiendo las indicaciones.

ATENCIÓN

En caso de conexión con dispositivos con mando de volante resistivos integrados (Universales), una vez terminada la instalación y la configuración del interfaz, será necesario continuar con la configuración del aparato, siguiendo las instrucciones que se detallan en el manual de usuario del propio autorradio.

DIPSWITCH

ADAPTATOR CABLE

ALPINE

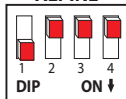

DIPSWITCH

ADAPTATOR CABLE

KENWOOD

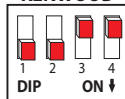

BLAUPUNKT

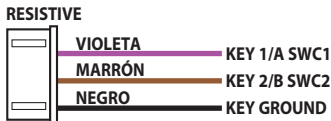
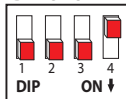

PHONOCAR

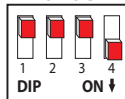

DIPSWITCH

ADAPTATOR CABLE

DIPSWITCH

ADAPTATOR CABLE

CLARION

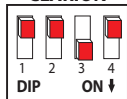

PIONEER

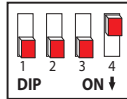

JVC >2011

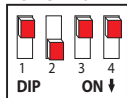

SONY

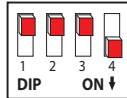

JVC 2011>

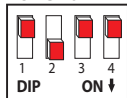

UNIVERSAL

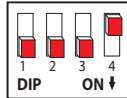

RESISTIVE

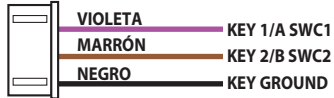



PHONOCAR S.p.a.

Via F.lli Cervi, 167/C - 42124 Reggio Emilia (Italy) - Tel. +39 0522 941621 • www.phonocar.com - e-mail: info@phonocar.it